





HE400SBR

Inspection chambers with frame B125

EN 124	B125	square frame	locking	double siphoning system
				

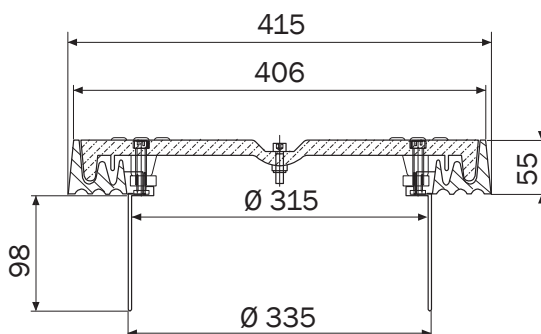
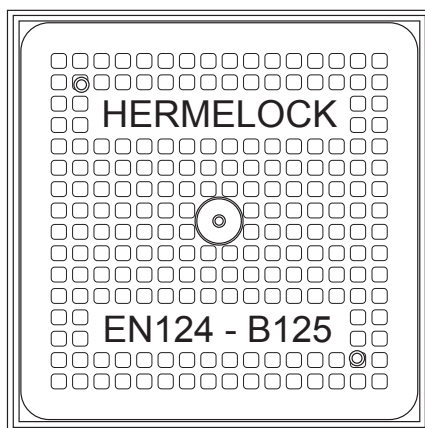

DESCRIPTION

Hermelock manhole covers are made of Polyurethane, reinforced with fiberglass with matching frame made of reinforced Polypropylene. Water-work covers Hermelock with adjustable frames (height margin 98mm) are suitable to be installed onto round synthetic chambers/tubes (PVC/HDPE).

ADVANTAGE PRODUCT

- Watertight to drainage water by double siphon system.
- Resisting loads according to the standards EN-124 class B-125
- Anti slippery design with little noise
- A smell-proof sealing (Double siphoning system)
- A locking system in 2 points
- Colour: Black

MATERIAL

Composite material

PLACE OF INSTALLATION

Group 2, class B125 →see EN124.

For use in car parks and pedestrian areas where only occasional vehicular access is likely.

OPTIONS

- Full watertightness and gas tightness can be obtained by putting additional sealing.
- Marking/logo on request
- key KE1

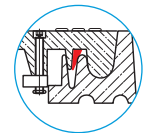

MANEUVERS OF THE COVER:

How to open the manhole cover:

1. Unlock 2 locking devices with means of hexagonal key 6mm or our key KE1 by turning into opposite way of clock, until resistance is felt or blocking.
2. Take out cover, this is easy with our key KE1.

To close, proceed in the opposite way:

1. Clean double siphon system in frame
2. Ensure that blocking device underneath cover is orientated to center cover.
3. Place cover in frame
4. By means of hexagonal key 6mm or key KE1 lock by turning way of clock, until resistance is felt. In his way block is lock underneath frame.
5. Cover is locked.

REFERENCE	ART.N°	KG	PACK.
HE400SBR		7,2	-

Sizes in mm - Weights, sizes and sketch are indicative - Uncontrolled distribution.